

# Calculating scale factors

1 Complete the sentences.

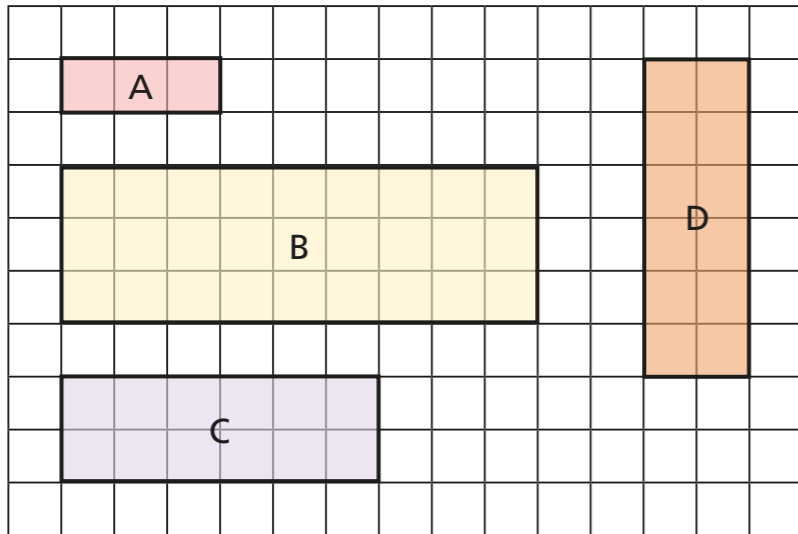

Shape B is an enlargement, by a scale factor of , of shape A.

Shape C is an enlargement, by a scale factor of , of shape A.

Shape D is an enlargement, by a scale factor of , of shape A.

2 Shape B is an enlargement of shape A. Shape C is not an enlargement of shape A.

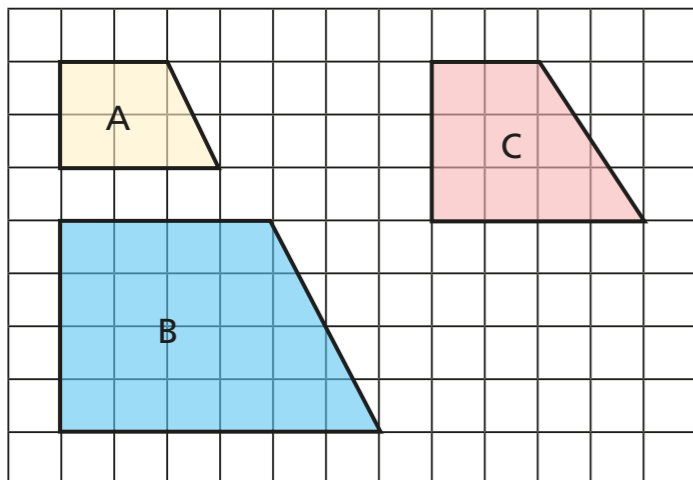

Talk to a partner about why this is the case.

3 Tick all the shapes that are an enlargement of shape A.

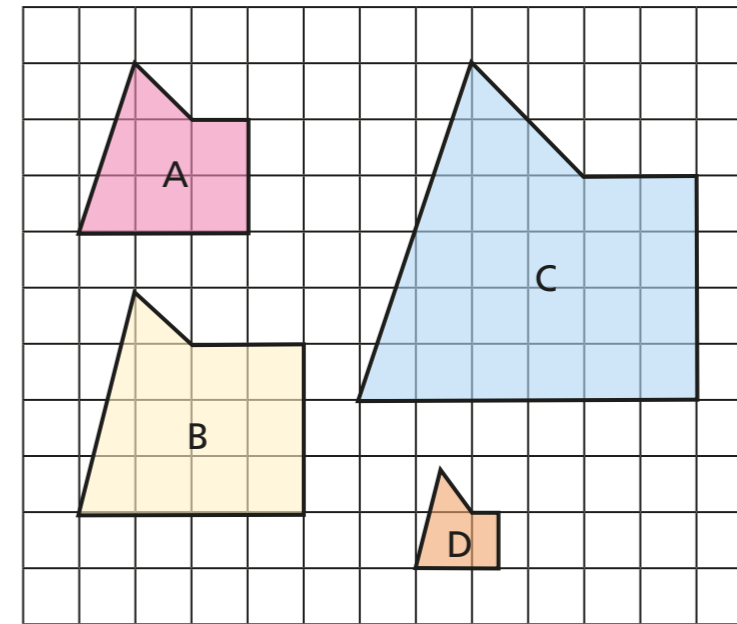

How do you know which shapes are enlargements?

4 The two triangles are similar.

Find the length of  $a$ .

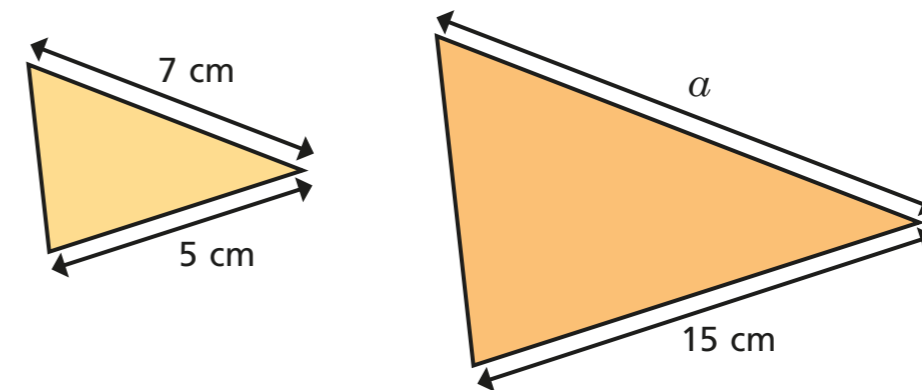

$a =$    $\text{cm}$

- 5 The two triangles are similar.  
Find the area of the smaller triangle.

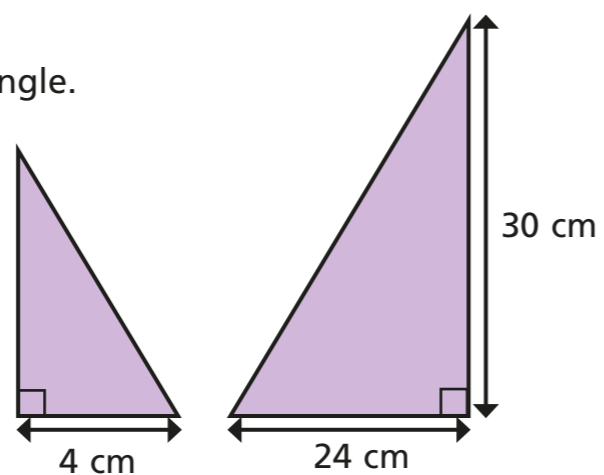

area =  cm<sup>2</sup>

- 6 These two children's toys are similar.  
Find the length marked  $y$ .

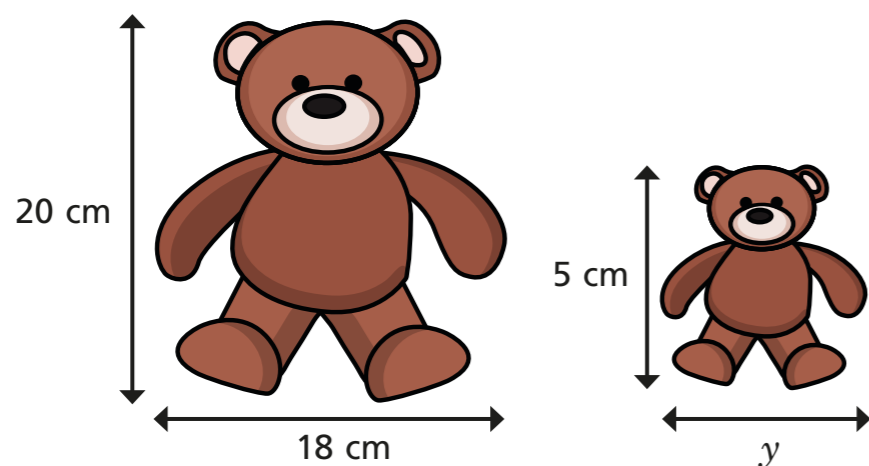

$y =$   cm

- 7 The rectangle is enlarged by a scale factor.  
The perimeter of the enlarged rectangle is 64 m.  
What is the scale factor of enlargement?

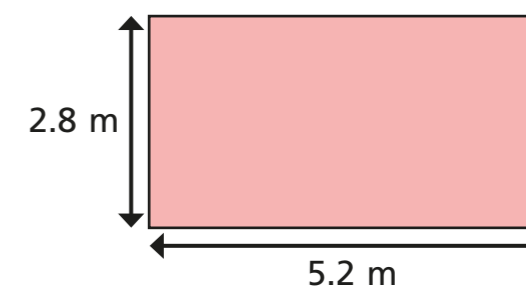

scale factor =

- 8 The diagram shows three similar triangles.  
Calculate the missing values.

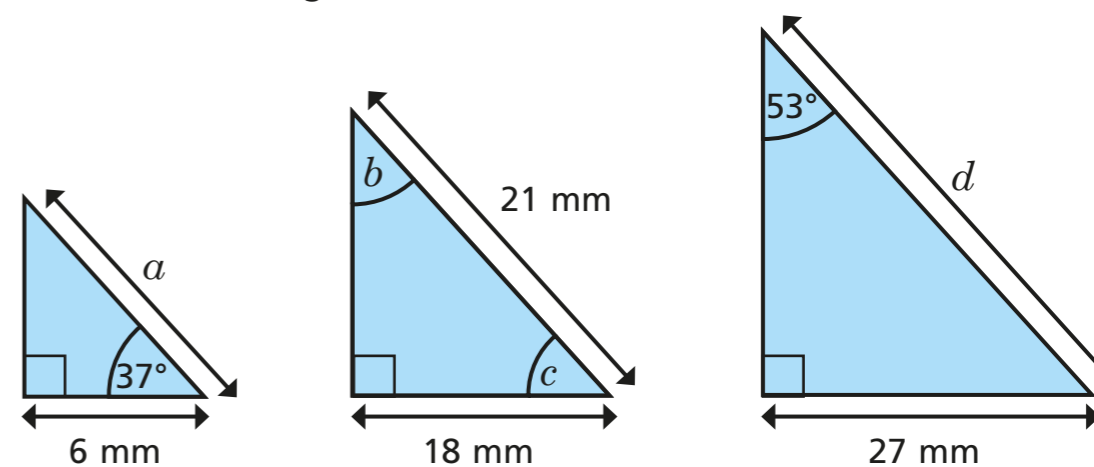

$a =$    $b =$    $c =$    $d =$